

ASSEMBLY INSTRUCTIONS
FOR
12 BOLT CHEVY WITH FACTORY C-CLIP AXLES*
*For additional vehicle compatibility, visit www.wilwood.com

**REAR AXLE DISC / DRUM INTERNAL PARKING BRAKE KIT
WITH 14.00" DIAMETER VENTED ROTOR (2.81 OFFSET)**

BASE PART NUMBER

140-10943

**DISC BRAKES SHOULD ONLY BE INSTALLED BY SOMEONE
EXPERIENCED AND COMPETENT IN THE INSTALLATION AND
MAINTENANCE OF DISC BRAKES
READ ALL WARNINGS**

WARNING

IT IS THE RESPONSIBILITY OF THE PERSON INSTALLING ANY BRAKE COMPONENT OR KIT TO DETERMINE THE SUITABILITY OF THE COMPONENT OR KIT FOR THAT PARTICULAR APPLICATION. IF YOU ARE NOT SURE HOW TO SAFELY USE THIS BRAKE COMPONENT OR KIT, YOU SHOULD NOT INSTALL OR USE IT. DO NOT ASSUME ANYTHING. IMPROPERLY INSTALLED OR MAINTAINED BRAKES ARE DANGEROUS. IF YOU ARE NOT SURE, GET HELP OR RETURN THE PRODUCT. YOU MAY OBTAIN ADDITIONAL INFORMATION AND TECHNICAL SUPPORT BY CALLING WILWOOD AT (805) 388-1188, OR VISIT OUR WEB SITE AT WWW.WILWOOD.COM. USE OF WILWOOD TECHNICAL SUPPORT DOES NOT GUARANTEE PROPER INSTALLATION. **YOU**, OR THE PERSON WHO DOES THE INSTALLATION MUST KNOW HOW TO PROPERLY USE THIS PRODUCT. IT IS NOT POSSIBLE OVER THE PHONE TO UNDERSTAND OR FORESEE ALL THE ISSUES THAT MIGHT ARISE IN YOUR INSTALLATION.

RACING EQUIPMENT AND BRAKES MUST BE MAINTAINED AND SHOULD BE CHECKED REGULARLY FOR FATIGUE, DAMAGE, AND WEAR.



Need Additional Information? Use Your
SmartPhone and Jump to Our Technical
Tips Section on Our Web Site.

DISC BRAKES
wilwood

WARNING

DO NOT OPERATE ANY VEHICLE ON UNTESTED BRAKES!
SEE MINIMUM TEST PROCEDURE WITHIN

ALWAYS UTILIZE SAFETY RESTRAINT SYSTEMS AND ALL OTHER AVAILABLE SAFETY EQUIPMENT WHILE OPERATING THE VEHICLE

IMPORTANT • READ THE DISCLAIMER OF WARRANTY INCLUDED IN THE KIT

NOTE: Some cleaners may stain or remove the finish on brake system components. Test the cleaner on a hidden portion of the component before general use.

Important Notice - Read This First

Before any tear-down or disassembly begins, review the following information:

- Review the wheel clearance diagram (figure 2, page 3) to verify that there is adequate clearance with the wheels you will be using with the installation.
- Verify the rear axle housing flange pattern, axle offset, and other critical measurements as outlined on page 3.
- This brake kit is not supplied with hydraulic lines or fittings and may require the purchase of additional lines or fittings to complete the installation. Wilwood offers an extensive listing of brake lines and fittings on our web site: www.wilwood.com.
- This brake kit is not supplied with parking brake cables hardware or adapters. Please see the note in the assembly instructions for vendor recommendations to purchase these parts.
- Due to OEM production differences and other variations from vehicle to vehicle, the fastener hardware and other components in this kit may not be suitable for a specific application or vehicle.
- It is the responsibility of the purchaser and installer of this kit to verify suitability / fitment of all components and ensure all fasteners and hardware achieve complete and proper engagement. Improper or inadequate engagement can lead to component failure.

Photographic Tip

Important and highly recommended: Take photos of brake system before disassembly and during the disassembly process. In the event, trouble-shooting photos can be life savers. Many vehicles have undocumented variations, photos will make it much simpler for Wilwood to assist you if you have a problem.

Exploded Assembly Diagram

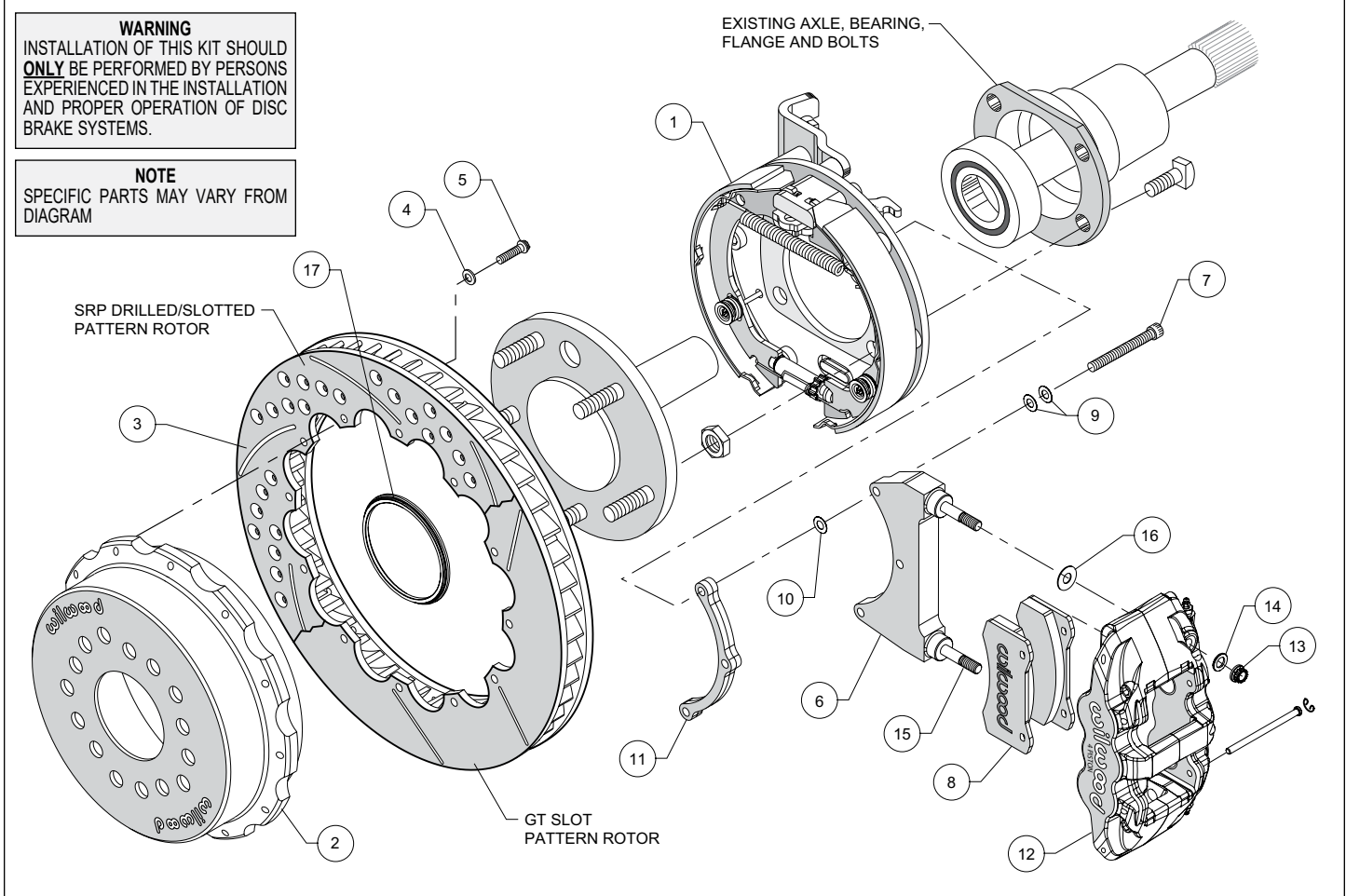

Figure 1. Typical Installation Configuration

Parts List

ITEM NO.	PART NO.	DESCRIPTION	QTY
1	249-9774/75	Bracket Kit (pair, one each, left and right)	1
2	170-13540	Hat, 5 x 4.50/4.75/5.00, 1.95 offset, 12 x 8.75 Bolt Circle	2
3	160-8402/03	Rotor, GT 1.10" Thk x 14.00" Dia, 12 x 8.75" Bolt Circle, Right & Left	2
3A	160-8400/01-BK	Rotor, Black, SRP Drilled and Slotted	2
4	240-11240	Washer, .265" I.D. x .500" O.D. x .063" Thick	24
5	230-8037	Bolt, 1/4-20 x .75" Long, 12 Point	24
6	249-10955/56	Bracket Caliper Mounting (pair, one each, right and left)	2
7	230-13565	Bolt, 5/16-24 x 1.75" Long, SHCS	6
8	150-20-6617K	Pad, BP-20 Compound, Axle Set	1
9	240-10191	Washer, .328" I.D. x .562" O.D. x .063" Thick	12
10	240-9609	Shim, .015" Thick	12
11	300-9504	Spacer, Caliper Bracket	2
12	120-13338-BK	Caliper, Aerolite 4R (pair, one each, right and left)	2
12A	120-13338-RD	Caliper, Aerolite 4R, Red	2
13	230-9182	Nut, 7/16-20 Self-Locking, 12 Point	4
14	240-11101	Washer, .453" I.D. x .750" O.D. x .063" Thick	4
15	230-9080	Stud, 7/16-14 x 7/16-20 x 3.375" Long (pre installed in bracket)	4
16	240-1848	Shim, .030" Thick	16
17	300-11337	Adapter, Rotor Registration	2

NOTES: P/N 230-8008 Rotor Bolt Kit, includes part numbers 230-8037 and 240-11240

P/N 249-10957L/R Caliper Mounting Bracket Kit, includes P/N's 230-9182, 230-9080, 240-1848, 240-11101 and 249-10955/56

P/N 300-9739 Spacer Kit, includes part numbers 230-13565, 240-10191, 240-9609 and 300-9504

Item 3A is an optional item and included with the (D) drilled rotor kits. Add "-D" to end of part number when ordering.

Item 12A is an optional item and included with the (R) red caliper kits. Add "-R" to end of part number when ordering.

General Information

Installation of this kit should **ONLY** be performed by persons experienced in the installation and proper operation of disc brake systems. Before assembling the Wilwood rear axle disc brake kit, double check the following items to ensure a trouble-free installation.

- Make sure this is the correct kit to fit the axle housing flange, not necessarily the rear end make. Many times after market manufacturers put a different make of axle housing flange on the stock rear end housing (see Figure 5). Example; Big Ford rear ends with Olds-Pontiac flanges, therefore, an Olds-Pontiac rear disc brake kit would be the correct kit to order. Also, shock clearance may be a problem. They may have to be modified and/or relocated to clear the Wilwood kit after final assembly.

- Inspect the package contents against the parts list to ensure that all components and hardware are included.

•Verify The Following Measurements Before Assembly.

- Bearing outside diameter.
- Axle housing flange mounting pattern to pattern in bracket.
- Stud pattern on axle flange to stud pattern in hat.
- Axle center register diameter is 2.80", Figure 3. This kit uses Wilwood's removable center register adapters. Rotors can either be centered on the axle register, i.e. *register-centric* or centered on the wheel studs, i.e. *stud-centric*. Due to variations in wheel stud final diameters, *register-centric* centering can be a more accurate method of centering the rotor to the axle. Wilwood offers various diameter adapters for purchase in addition to the ones supplied in this kit, see Table 1.

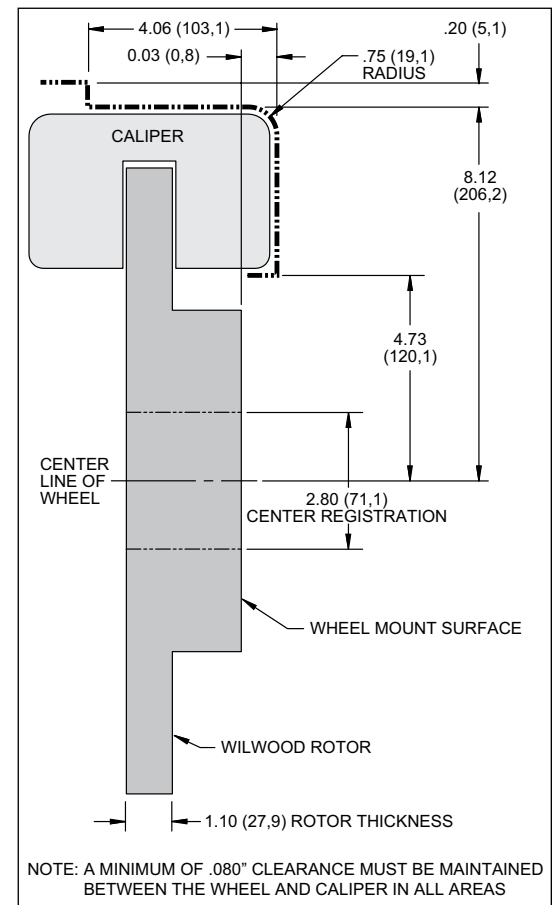

Figure 2. Wheel Clearance Diagram

General Information (Continued) and Disassembly Instructions

- Dimension from wheel side of axle flange to wheel side of axle housing flange (see Figure 6, lower right hand corner). This dimension is critical to ensure proper alignment of the rotor to the caliper, and should match offset given in the kit description.
- Verify that the wheel axle stud size is 0.50" diameter. The Wilwood hats utilized in these kits are drilled for 0.50" diameter wheel studs.
- Maximum axle flange diameter must be no larger than 6.61" w/.050" x 45° chamfer (see Figure 3).

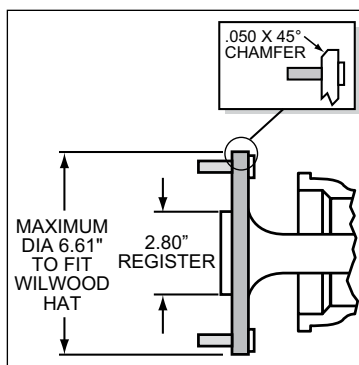

Figure 3. Axle Flange Maximum Dimension

This kit includes a 3.06" center I.D. hat or rotor assembly and a 2.80" hub register adapter ring to accommodate the installation of this kit on axles of either dimension. For axles with different center register diameters, please consult the table below for optional adapter ring sizes.

PART NO.	REGISTER I.D.	NOTE
NO ADAPTER USED	3.06"	ROTOR CENTER HOLE I.D.
300-13328	2.88"	OPTIONAL
300-11732	2.86"	OPTIONAL
300-11962	2.84"	OPTIONAL
300-11338	2.82"	OPTIONAL
300-11337	2.80"	SUPPLIED WITH KIT
300-13506	2.79"	OPTIONAL
300-11532	2.78"	OPTIONAL
300-16434	2.75"	OPTIONAL
300-11803	2.52"	OPTIONAL
300-11901	2.50"	OPTIONAL
300-12761	2.44"	OPTIONAL
300-11653	2.18"	OPTIONAL
300-11339	2.00"	OPTIONAL (Machine to fit I.D.)

Table 1. Center Register Adapters

Disassembly Instructions

- Disassemble the original equipment rear brakes:
 - Raise the rear wheels off the ground and support the rear suspension according to the vehicle manufacturer's instructions.

Completely disassemble the stock brake system down to the bare axle. Degrease and remove any dings and burrs on housing flange as well as axle flange which may interfere with brake assembly.

Assembly Instructions

IMPORTANT:

- To ensure maximum performance from your parking brake system, the cables must be routed as straight as possible. Bends in the cable can significantly reduce efficiency and thus reduce pull force at the brake. Tight bends must be avoided with a minimum recommended bend radius of 6" to 8".
- Cables should be properly restrained to prevent "straightening" of bends when tension is applied. Restrain movement of cable by affixing the cable sheath to body or chassis by fitting cable clamps at various points over the length of cable or by using original equipment cable attachments points. The clamping method chosen will require that cable sheath be held tightly without movement, crushing or causing interference to the internal cable.
- Cables must be initially pre-stretched by multiple applications of the brake handle, then re-adjusted to correct tension.

Assembly Instructions (numbers in parenthesis refer to the parts list/diagram on the preceding pages): **CAUTION:** All mounting bolts must fully engage insert nuts. Be sure to check that all bolts are either flush or protruding through flanged side of insert nut after shimming.

- Slide the bracket kit assembly (1) onto the housing flange and then insert the axle assembly through the center hole of the bracket kit assembly (1). Secure using the stock Original Equipment Manufacturer (OEM) bolts and nuts. Stock OEM hex nuts that retain the bracket kit assembly (1) should be on the wheel side of the bracket. Apply red *Loctite*® 271 to the stock OEM bolt threads and torque to OEM specifications. Make sure the bracket kit assembly (1) brake pads are FACING OUTWARD TOWARDS THE WHEEL.

- With the larger I.D. side of the rotor (3) facing away from the hat (2), bolt rotor (3) to hat (2) through the backside of the rotor using washers (4) and bolts (5). Apply red *Loctite*® 271 to the bolt threads and torque to 155 in-lb using a criss-cross pattern. For an added measure of security, the bolts may be safety wired using standard 0.032 inch diameter stainless steel safety wire as shown in Figure 4. Please refer to Wilwood's data sheet DS-386 (available at www.wilwood.com/Pdf/DataSheets/ds386.pdf) for complete safety wire installation instructions.

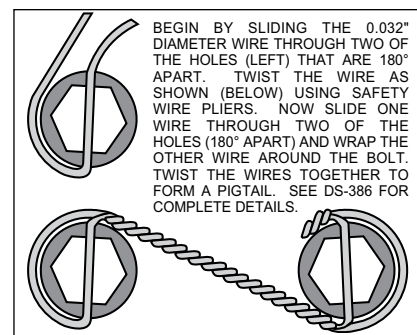

Figure 4. Safety Wire Diagram

Assembly Instructions (Continued)

- Slide the rotor registration adapter (17) onto the axle register on the axle flange with the smaller O.D. facing toward the rotor/hat (2). Align the correct hole pattern in the hat with the stud pattern on the axle flange. **NOTE:** *Some OEM and aftermarket axles come with stud sizes larger than 0.50" diameter.* Verify stud size and have a qualified machine shop drill the hats to the correct size, if necessary. Slide the hat/rotor assembly (2 and 3) over the wheel studs covering the bracket kit assembly (1) and against the axle flange face. Check to be sure the hat seats squarely against the hub. Install three lug nuts (finger tighten) to keep the rotor/hat assembly in place while continuing with the installation.
- NOTE:** *Please reference the caution statement at the beginning of the assembly instructions.* The caliper mounting bracket assembly (6) should be installed first with clean, dry threads on the mounting bolts (7). Install the bracket from the rear side of the bracket kit assembly (1) by sliding bolt (7) through two flat washers (9), bracket (6), shim washer (10) and finally through the spacer (11), see Figure 1. **NOTE:** *End of bolt should not exceed inside face of insert. The bracket must tighten squarely against the back side of the bracket kit assembly (1).* Inspect for interference from casting irregularities, machining ridges, burrs, etc. Use one thin shim (10) between the bracket (6) and spacer (11) during initial trial fitting.
- Lubricate caliper mounting studs and nuts with lightweight oil. Install one washer (16) over each pre-installed stud (15) on the radial mount bracket (6). Slide the caliper (12) in place over the studs and rotor, then install the washer (14) and lock nut (13) to hold the caliper in place. The caliper bleed screws should be pointing up. Snug the lock nuts (13) and check that the rotor (3) is centered in the caliper (12). Add or subtract .015" shims (10) as necessary between the caliper mounting bracket (6) and the spacer (11) to center the caliper (12).
- Remove the two pad retaining pins from the caliper (12) by carefully popping out the pin retaining clips and sliding out the pins. Insert the brake pads (8) into the caliper from the bottom, Figure 1. With the friction material facing the rotor, secure the brake pads in place with the pad retaining pins and clips. Reinstall the caliper onto the caliper mounting bracket and temporarily tighten the lock nuts. Check that the top of the brake pad is flush with the outside diameter of the rotor. If not, adjust by adding or subtracting shims (16) between the caliper and the bracket.
- Adjust the parking brake shoes outward (using a drum shoe adjustment tool available at your local auto parts store) while spinning the hat (2) until a slight drag is felt against the hat/drum. Remove the lug nuts that were holding the hat/rotor in place. Install the wheel and lug nuts. Check to see that the wheel rotates freely without interference.
- Once all clearances have been checked, remove the wheel, caliper, hat/rotor from the bracket kit assembly (1). Secure the caliper mounting bracket (6) to the bracket kit assembly (1) using red *Loctite*® 271. Torque bolts (7) to 180 **in-lb**. Reinstall the hat/rotor assembly and again use lug nuts to hold it in place. Reinstall the caliper, torque the caliper nuts (13) to 47 **ft-lb**.
- NOTE:** *Clevis and cable kits which attach to the parking brake assembly are not included in the Wilwood parking brake kit.* Wilwood offers a generic style parking brake cable kit, P/N 330-9371 for this application which can be ordered separately from your local Wilwood dealer or by calling Wilwood customer service at (805) 388-1188.
- NOTE:** *OEM rubber brake hoses generally cannot be adapted to Wilwood calipers. The caliper inlet fitting is a 1/8-27 NPT.* The preferred method is to use steel adapter fittings at the caliper, either straight, 45 or 90 degree (use PTFE tape on pipe threads of adapter fitting for proper sealing to caliper) and enough steel braided line to allow for full suspension travel and turning radius, lock to lock. **Carefully route lines to prevent contact with moving suspension, brake or wheel components.** Wilwood hose kits are designed for use in many different vehicle applications and it is the installer's responsibility to properly route and ensure adequate clearance and retention for brake hose components.
- Specified brake hose kits may not work with all Years, Makes and Models of vehicle that this brake kit is applicable to, due to possible OEM manufacturing changes during a production vehicle's life. It is the installer's responsibility to ensure that all fittings and hoses are the correct size and length, to ensure proper sealing and that they will not be subject to crimping, strain and abrasion from vibration or interference with suspension components, brake rotor or wheel.
- In absence of specific instructions for brake line routing, the installer must use his best professional judgment on correct routing and retention of lines to ensure safe operation. Test vehicle brake system per the 'minimum test' procedure stated within this document before driving. After road testing, inspect for leaks and interference. Initially after install and testing, perform frequent checks of the vehicle brake system and lines before driving, to confirm that there is no undue wear or interference not apparent from the initial test. Afterwards, perform periodic inspections for function, leaks and wear in a interval relative to the usage of vehicle.

Assembly Instructions (Continued)

- Repeat this entire procedure for the other wheel.
- Bleed the brake system. Reference the additional information and recommendations on page 7 for proper bleeding instructions.
- Remove the lug nuts that were used to hold the hat/rotor assembly in place during caliper installation. Install the wheel and lug nuts, torque to OEM specifications.
- Bed-in the brake pads per the procedure on page 8.

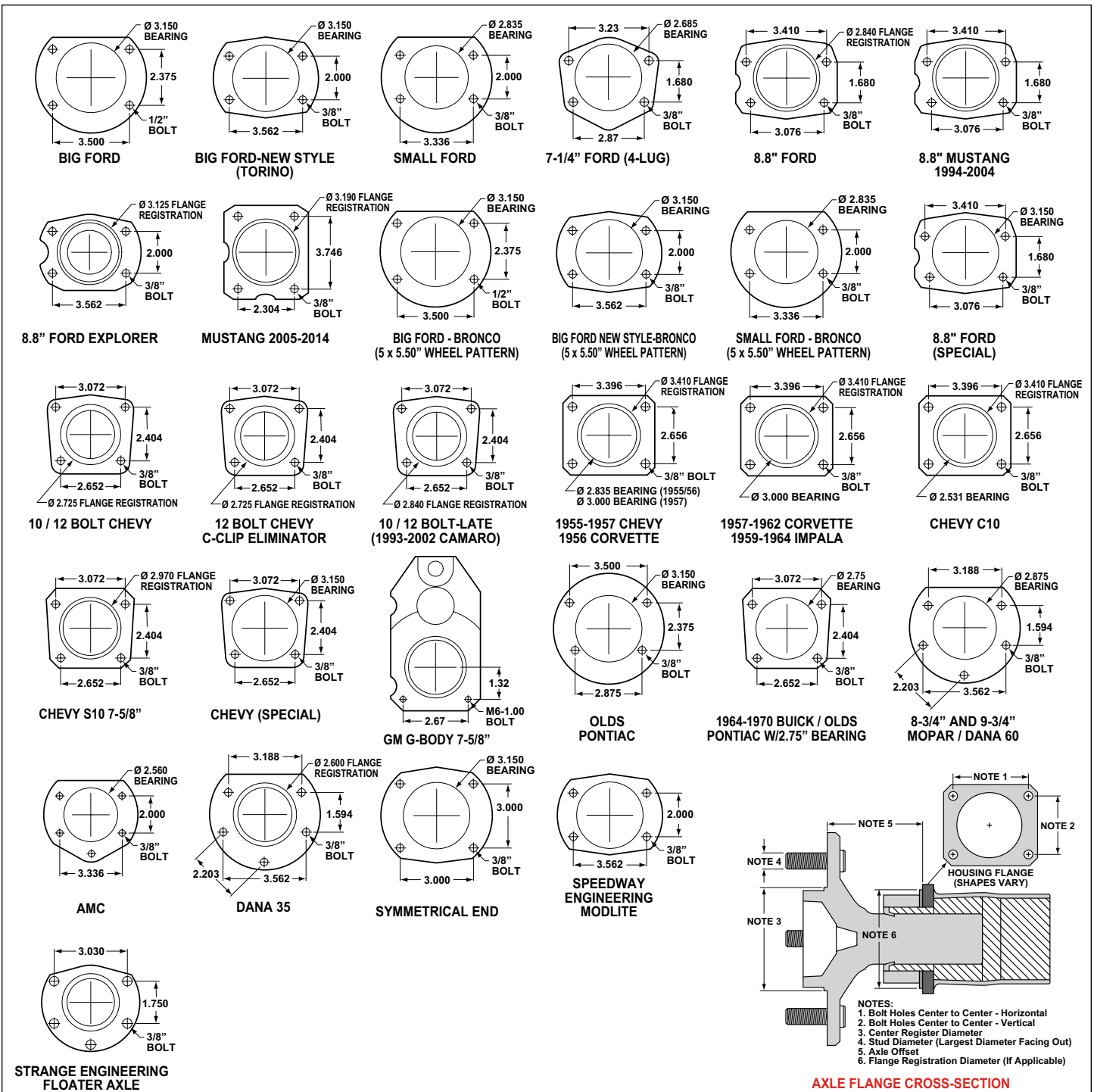

Figure 5. Rear Housing Flange Chart and Axle Flange / Offset Cross-Section

Additional Information and Recommendations

- Fill and bleed the new system with Wilwood Hi-Temp° 570 grade fluid or higher. For severe braking or sustained high heat operation, use Wilwood EXP 600 Plus Racing Brake Fluid. Used fluid must be completely flushed from the system to prevent contamination. **NOTE:** *Silicone DOT 5 brake fluid is **NOT** recommended for racing or performance driving.*
- To properly bleed the brake system, begin with the caliper farthest from the master cylinder. Bleed the outboard bleed screw first, then the inboard. Repeat the procedure until all calipers in the system are bled, ending with the caliper closest to the master cylinder. **NOTE:** *When using a new master cylinder, it is important to bench bleed the master cylinder first.*
- If the master cylinder is mounted lower than the disc brake calipers, some fluid flowback to the master cylinder reservoir may occur, creating a vacuum effect that retracts the caliper pistons into the housing. This will cause the pedal to go to the floor on the first stroke until it has “pumped up” and moved all the pistons out against the pad again. A Wilwood in-line two pound residual pressure valve, installed near the master cylinder will stop the fluid flowback and keep the pedal firm and responsive.
- Test the brake pedal. It should be firm, not spongy and stop at least 1 inch from the floor under heavy load.
 - If the brake pedal is spongy, bleed the system again.
 - If the brake pedal is initially firm, but then sinks to the floor, check the system for fluid leaks. Correct the leaks (if applicable) and then bleed the system again.
 - If the brake pedal goes to the floor and continued bleeding of the system does not correct the problem, a master cylinder with increased capacity (larger bore diameter) will be required. Wilwood offers various lightweight master cylinders with large fluid displacement capacities (custom fabricated mounting may be required).
- **NOTE:** *With the installation of after market disc brakes, the wheel track may change depending on the application. Check your wheel offset before final assembly.*
- On some models of disc brake spindles there are “ears” where the OEM calipers were mounted and these “ears” interfere with the assembly of the Wilwood disc brake kit. If it becomes necessary to remove these “ears”, remove as little as possible being careful not to cut away any of the mounting holes that may be required to bolt on the caliper mounting bracket.
- If after following the instructions, you still have difficulty in assembling or bleeding your Wilwood disc brakes, consult your local chassis builder, or retailer where the kit was purchased for further assistance.

Brake Testing

WARNING • DO NOT DRIVE ON UNTESTED BRAKES BRAKES MUST BE TESTED AFTER INSTALLATION OR MAINTENANCE MINIMUM TEST PROCEDURE

- Make sure pedal is firm: Hold firm pressure on pedal for several minutes, it should remain in position without sinking. If pedal sinks toward floor, check system for fluid leaks. **DO NOT** drive vehicle if pedal does not stay firm or can be pushed to the floor with normal pressure.
- At very low speed (2-5 mph) apply brakes hard several times while turning steering from full left to full right, repeat several times. Remove the wheels and check that components are not touching, rubbing, or leaking.
- Carefully examine all brake components, brake lines, and fittings for leaks and interference.
- Make sure there is no interference with wheels or suspension components.
- Drive vehicle at low speed (15-20 mph) making moderate and hard stops. Brakes should feel normal and positive. Again check for leaks and interference.
- Always test vehicle in a safe place where there is no danger to (or from) other people or vehicles.
- Always wear seat belts and make use of all safety equipment.

Pad and Rotor Bedding

BEDDING STEPS FOR NEW PADS AND ROTORS – ALL COMPOUNDS

Once the brake system has been tested and determined safe to operate the vehicle, follow these steps for the bedding of all new pad materials and rotors. These procedures should only be performed on a race track, or other safe location where you can safely and legally obtain speeds up to 65 MPH, while also being able to rapidly decelerate.

- Begin with a series of light decelerations to gradually build some heat in the brakes. Use an on-and-off the pedal technique by applying the brakes for 3-5 seconds, and then allow them to fully release for a period roughly twice as long as the deceleration cycle. If you use a 5 count during the deceleration interval, use a 10 count during the release to allow the heat to sink into the pads and rotors.
- After several cycles of light stops to begin warming the brakes, proceed with a series of medium to firm deceleration stops to continue raising the temperature level in the brakes.
- Finish the bedding cycle with a series of 8-10 hard decelerations from 55-65 MPH down to 25 MPH while allowing a proportionate release and heat-sinking interval between each stop. The pads should now be providing positive and consistent response.
- If any amount of brake fade is observed during the bed-in cycle, immediately begin the cool down cycle.
- Drive at a moderate cruising speed, with the least amount of brake contact possible, until most of the heat has dissipated from the brakes. Avoid sitting stopped with the brake pedal depressed to hold the car in place during this time. Park the vehicle and allow the brakes to cool to ambient air temperature.

COMPETITION VEHICLES

- If your race car is equipped with brake cooling ducts, blocking them will allow the pads and rotors to warm up quicker and speed up the bedding process.
- Temperature indicating paint on the rotor and pad edges can provide valuable data regarding observed temperatures during the bedding process and subsequent on-track sessions. This information can be highly beneficial when evaluating pad compounds and cooling efficiencies.

POST-BEDDING INSPECTION – ALL VEHICLES

- After the bedding cycle, the rotors should exhibit a uniformly burnished finish across the entire contact face. Any surface irregularities that appear as smearing or splotching on the rotor faces can be an indication that the brakes were brought up to temperature too quickly during the bedding cycle. If the smear doesn't blend away after the next run-in cycle, or if chatter under braking results, sanding or resurfacing the rotors will be required to restore a uniform surface for pad contact.

PRE-RACE WARM UP

- Always make every effort to get heat into the brakes prior to each event. Use an on-and-off the pedal practice to warm the brakes during the trip to the staging zone, during parade laps before the flag drops, and every other opportunity in an effort to build heat in the pads and rotors. This will help to ensure best consistency, performance, and durability from your brakes.

DYNO BEDDED COMPETITION PADS AND ROTORS

- Getting track time for a proper pad and rotor bedding session can be difficult. Wilwood offers factory dyno-bedded pads and rotors on many of our popular competition pads and **Spec 37** GT series rotors. Dyno-bedded parts are ready to race on their first warm up cycle. This can save valuable time and effort when on-track time is either too valuable or not available at all, Dyno-bedding assures that your pads and rotors have been properly run-in and are ready to go. Contact your dealer or the factory for more information on Wilwood Dyno-Bedding services.

NOTE: NEVER allow the contact surfaces of the pads or rotors to be contaminated with brake fluid. Always use a catch bottle with a hose to prevent fluid spill during all brake bleeding procedures.

Parking Brake

WARNING • PARKING BRAKE

- Parking brake must be properly adjusted before use and must be manually readjusted for wear if parking brake handle or foot lever travel becomes excessive.
- The holding ability of the brake should be tested by stopping on a sloping surface and applying the parking brake while holding car with the hydraulic foot brake. This should be accomplished both facing up and down hill.
- Do not rely exclusively on the parking brake to hold the car; Curb wheels as recommended by the applicable diagram and put gear selector in park, or shift into first gear or reverse with a manual transmission.

- Diagram A - When parking facing downhill, turn front wheels towards the curb or right shoulder. This will keep from rolling into traffic if the brakes become disengaged.
- Diagram B - Turn the steering wheel to the left so the wheels are turned towards the road if you are facing uphill with a curb. The tires will catch the curb if the car rolls backward.
- Diagram C - When facing uphill without a curb, turn the wheels sharply to the right. If the vehicle rolls, it will go off the road rather than into traffic.
- When parking on a hill, always set the parking brake and move the gear selector into park, or shift into first or reverse gear if your vehicle has a manual transmission.

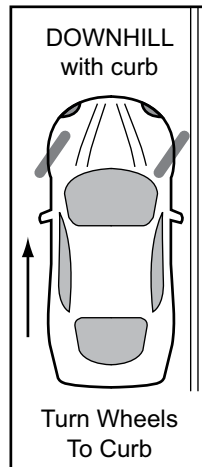

Diagram A

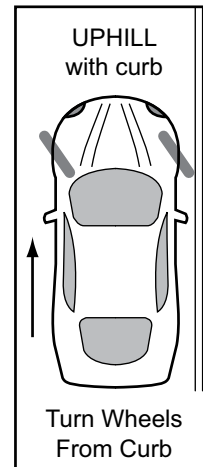

Diagram B

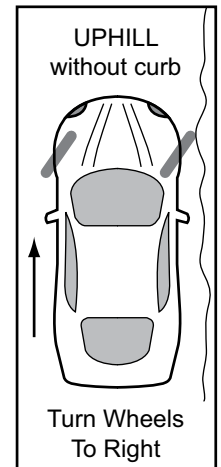

Diagram C

Connect with Wilwood

Wilwood Facebook 

Wilwood Instagram 

Wilwood Twitter 

Wilwood YouTube 

Associated Components

<u>PART NO.</u>	<u>DESCRIPTION</u>
260-13706	Wilwood Residual Pressure Valve (2 lb for disc brakes)
260-13707	Wilwood Residual Pressure Valve (10 lb for drum brakes)
260-8419	Wilwood Proportioning Valve, Knob Style
260-8420	Wilwood Proportioning Valve, Lever Style
260-11179	Wilwood Combination Proportioning Valve with Brake Light Switch
290-0632	Wilwood Racing Brake Fluid (Hi-Temp° 570) (12 oz)
290-6209	Wilwood Racing Brake Fluid (EXP 600 Plus) (16.9 oz)
340-13831	Wilwood Floor Mount Brake Pedal (with balance bar)
340-13832	Wilwood Swing Mount Brake Pedal (with balance bar)
260-6764	Wilwood 3/4 inch High Volume Aluminum Master Cylinder
260-6765	Wilwood 7/8 inch High Volume Aluminum Master Cylinder
260-6766	Wilwood 1 inch High Volume Aluminum Master Cylinder
260-4893	1-1/16 inch Tandem Master Cylinder (aluminum housing)
260-8555	Wilwood 1 inch Aluminum Tandem Chamber Master Cylinder
260-8556	Wilwood 1-1/8 inch Aluminum Tandem Chamber Master Cylinder
220-0506	Stainless Steel Braided Flexline Kit, Universal, 14 Inch, Domestic, 3/8-24 IF
220-7699	Stainless Steel Braided Flexline Kit, Universal, 16 Inch, Domestic, 3/8-24 IF
220-8307	Stainless Steel Braided Flexline Kit, Universal, 18 Inch, Domestic, 3/8-24 IF
330-9371	Cable Kit, Parking Brake, Universal